

CT 200 - Honda  
(c) Contec GmbH 2002

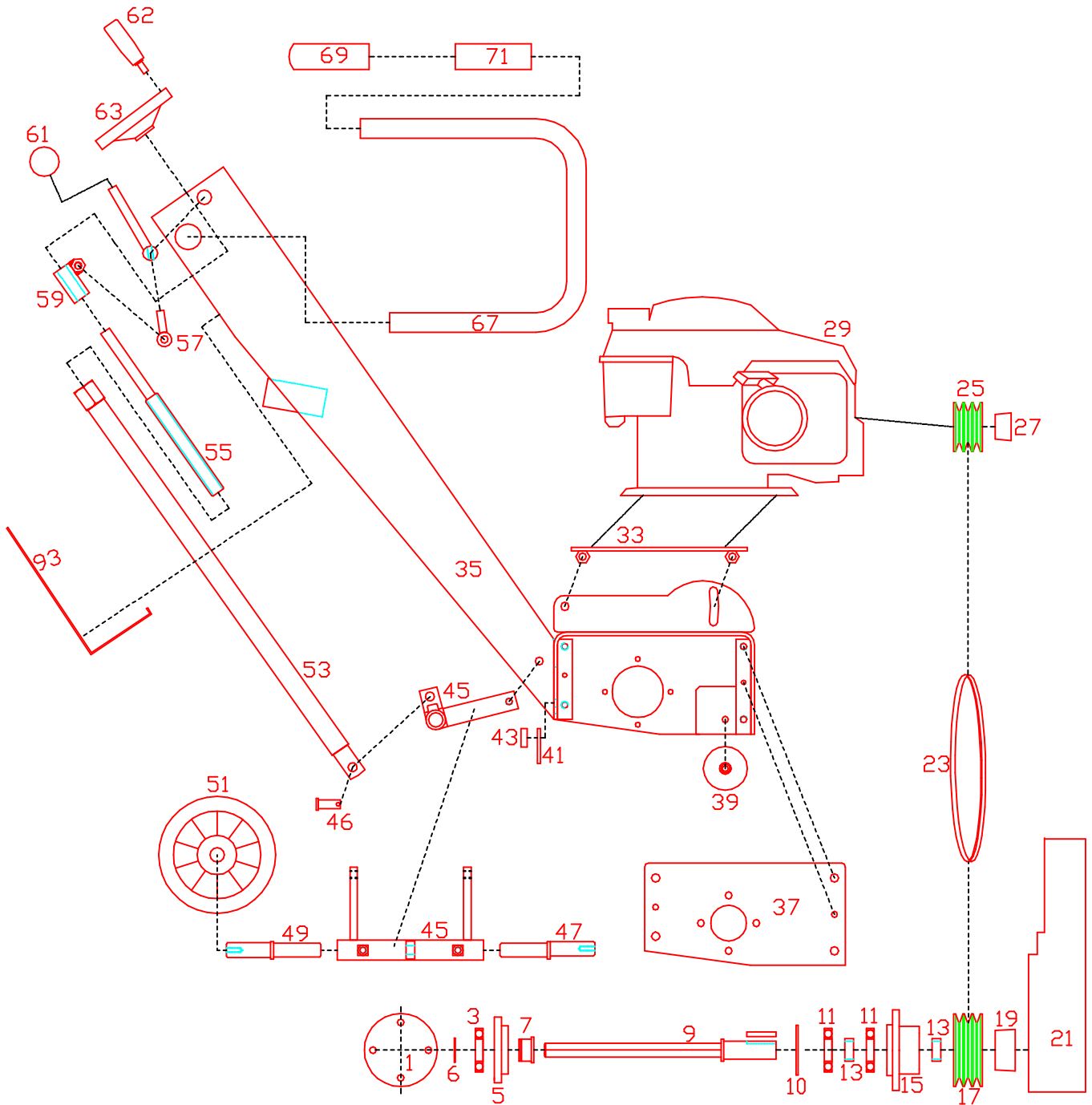

CT 60 Seitenfräse f. CT 200 / CT 60 Edger f. CT 200  
 (c) Contec GmbH 2003

Werkzeuge für CT 60  
 Tools for CT 60  
 (c) Contec GmbH 2003

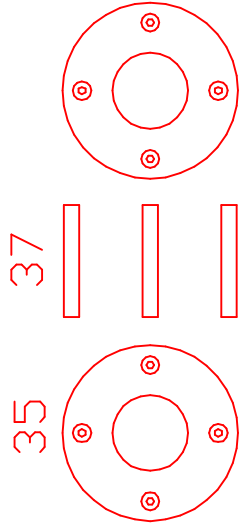

24 Lamellen /  
 24 cutters  
 24 Scheiben /  
 24 spacers

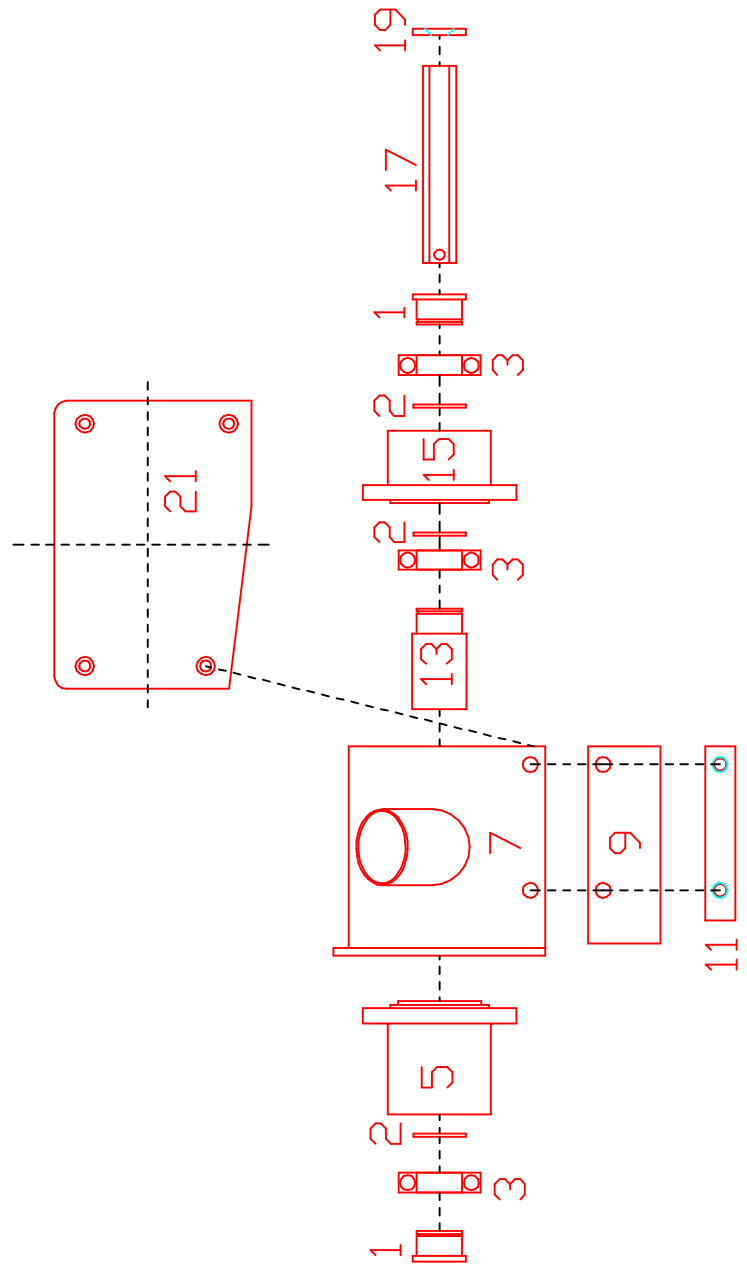
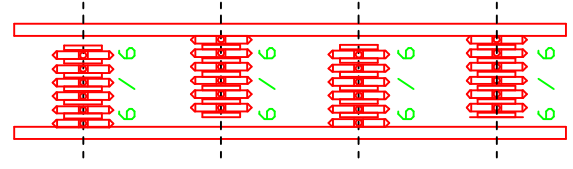

Werkzeuge für CT 200  
 Tools for CT 200  
 (c) Contec GmbH 2003

100 Trommel / drum

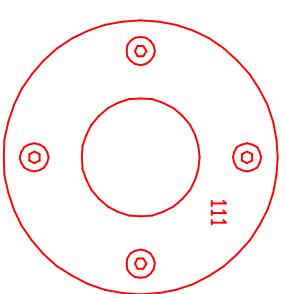
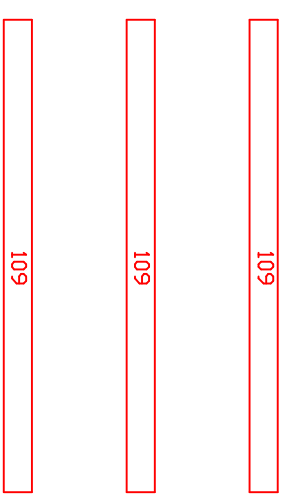
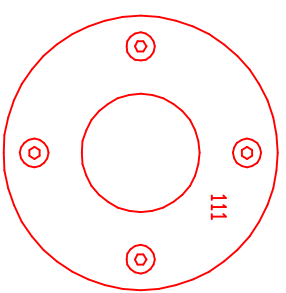

101  
 76 Lamellen /  
 76 cutters /  
 76 Scheiben /  
 76 spacers



103  
 40 Schalllamellen /  
 40 milling flails /  
 72 Scheiben /  
 72 spacers



105  
 126 Strahlenlamellen /  
 126 beam flails /  
 128 Scheiben /  
 128 spacers

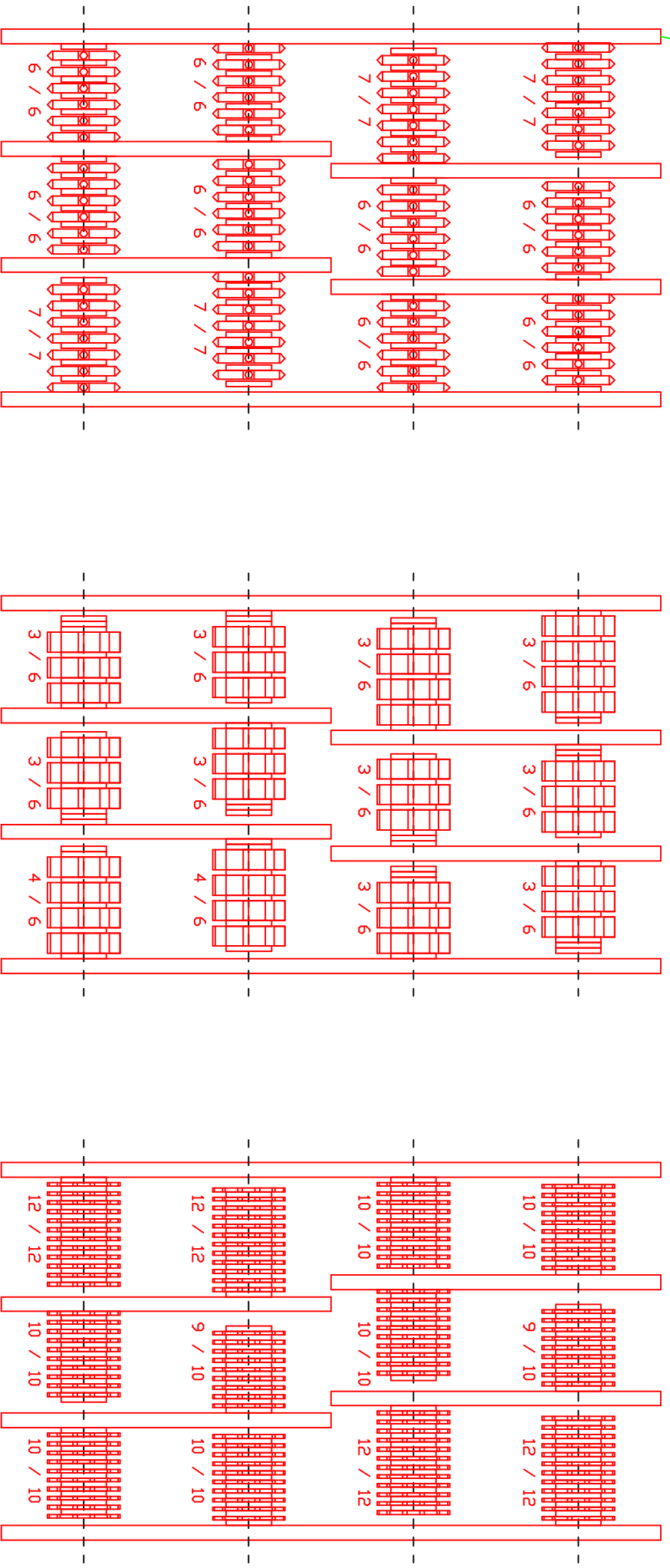

CT 250 Stückliste / Parts List

Artikel-Nr. / Part-No.	Description 1	Description 2	D-Nr	Weight KG
17-10-05-01	Right Side Cover Bearing Housing CT200		1	0,20
61-20-60-06	Bearing for right Bearing Housing CT200	and for Sideplaner CT 60	3	0,13
17-17-05-02	Right Bearing Housing CT200		5	0,40
61-30-00-30	Circlip for right side Bearing Housing	CT200/CT60	6	0,00
17-21-07-02	Hexagon Insidering Bearing Housing	Main Axis and Side Planer CT200	7	0,07
17-21-07-01	Drive Shaft heavy Duty CT200		9	2,05
61-30-01-47	Circlip for left side Bearing Housing	CT200	10	0,00
61-20-60-05	Bearing for left Bearing Housing CT200		11	0,09
17-10-07-03	Distance Ring Bearing Housing CT200		13	0,03
17-17-06-01	Left Bearing Housing CT200		15	0,99
90-24-95-3TB	Drum Pulley CT200		17	1,04
90-24-16-10-25	Taperlock Drum CT200		19	0,37
17-10-04-01	Belt Cover CT200		21	1,28
70-24-10-710	Belt Electric CT200		23	0,06
70-24-10-737	Belt Petrol Honda CT200		23	0,06
70-24-10-750-US	Belt US Version only for 3HP Motor CT200		23	0,07
90-24-63-3TB	Motor Pulley CT200		25	0,47
90-24-11-08-24	Taperlock Motor 2 KVA, 230 Volt CT200		27	0,11
90-24-11-08-28	Taperlock Motor 3 KVA, 400 Volt CT200		27	0,09
90-24-11-08-3HP-US	Taperlock Motor CT200 3 HP US Version		27	0,08
90-24-11-08-Honda	Taperlock Motor Honda 5,5 HP CT 200		27	0,14
55-03-00-20	Motor 2 KVA, 230 Volt, 50 HZ, Elephant		29	26,00
55-03-00-30	Turbine Motor 3 KW, 400 Volt CT 200/	Tornado/Elephant	29	27,00
55-03-23-40	Turbine Motor 3 KW, 230 Volt 3-Phase	CT200/Tornado/Elephant	29	27,00
56-GX-160-K1-4	Motor 5,5 HP for CT200		29	0,00
17-10-10-01	Bracket for Single Fase Motor CT200		31	0,35
17-10-10-01-US-H	Rear Bracket for Single Fase Motor	230 Volt US Version CT 200	31	0,44
17-10-10-01-US-V	Front Bracket for Single Fase Motor	230 Volt US Version CT 200	31	0,44
17-10-10-02-US	Bracket for Single Fase Motor 230 Volt	US Version CT 200	31	0,43
17-10-02-01	Mounting Plate Motor CT200		33	2,00
17-10-01-00	Machine Frame CT200		35	27,00
17-10-01-02	Ride Side Plate Machine Frame CT200		37	0,00
80-20-60-40	Front Wheel CT200		39	0,19
70-23-02-30	Rubber Sealing CT200		41	0,06

CT 250 Stückliste / Parts List

17-10-11-01	Bracket for Rubber Sealing CT200	43	0,30
17-10-09-01	Level Adjustment Back Wheel CT200	45	0,80
60-33-12-25	Connecting Pin for lifting Rod CT 200	46	0,00
30-10-08-05	Axis out of centre Rear Wheel CT 200	47	0,38
30-10-08-04	Axis Rear Wheel CT200	49	0,33
80-20-31-60	Rear Wheel CT200/M200	51	1,14
17-10-08-03	Height Adjustment Pipe CT200	53	1,05
17-10-08-02	Height Adjustment Screw CT200	55	0,45
61-50-10-40	Eye Scrw for Quick Lever CT 200	57	0,04
17-10-08-01	Holder for Spindle CT200	59	0,18
90-21-45-12	Golf Ball CT200	60	0,07
17-10-13-01	Handle Height Adjustment CT200	61	0,40
90-21-95-51	Revolving Pin for Handwheel CT 200	62	0,08
90-21-95-50	Level Adjustment Wheel CT200	63	0,38
50-20-10-20-K	Switch-Socket-Combination Omega/CT200	65	0,50
50-20-10-30-K	Switch-Socket-Combination Omega/CT200	65	0,63
18-10-07-01	Handle complete Omega/CT200	67	1,40
70-21-26-10	Rubber Grip closed Side CT 200	69	0,06
70-21-26-11	Rubber Grip open Side CT 200/Omega	71	0,06
51-10-10-01	Switch Box For Motor Protective	81	0,00
51-20-30-01-US	Low Voltage Protective CT200 US-Version	83	0,00
51-10-0-20-US	Switch Motor Protective CT200 110 Volt	85	0,00
18-10-01-05	Handle Arm Cover Omega/CT200	93	0,88
95-16-45-05	Tungston Carbide Cutters 45 / 5 CT200	101	0,04
95-16-42-10	Milling Flail Cutters 42 / 10 CT200/350	103	0,08
95-16-42-12	Steel Cutters Beam Flails 42 / 12	105	0,01
95-16-24-13	Spacer CT200/350	107	0,01
95-10-200-A	Axis for Drum CT200	109	0,19
18-10-01-08	Cover 110 V for Switch Omega/CT200		286,00
472-47			0,00
50-10-11-16	230 Volt Plug CT 200		0,00
50-20-20-14	Reverse plug 16 A, 400 Volt CT 200		0,00
50-25-11-30	Kabel between Plug / Switch 2 KW		0,00
50-25-11-31	Kabel between Switch / Plug 3 KW		0,00
50-25-11-32	Kabel between Motor / Switch 230 Volt		0,00
50-25-11-33	Kabel between Motor / Switch 400 Volt		0,00

CT 250 Stückliste / Parts List

51-20-30-01	Motor Protective 2 KVA, 230 Volt CT200		0,00
51-20-30-02	Motor Protective 3 KW, 400 Volt CT200		0,00
51-20-30-03	Low Voltage Protective 400 Volt CT200		0,00
51-20-30-04	Low Voltage Protective 230 Volt CT200		0,00
55-03-00-21	Ventilator Cover for Motor 2 KVA, 230 V	Elephant/CT200	420,00
55-03-00-22	Kondenser Motor 2 KW EMG CT 200		0,50
55-03-00-23	Kondenser Motor 2 KW EMG CT 200		0,50
55-03-04-20	Motor 2 KVA, 230 Volt, 50 HZ, Elephant		19,30
56-160-10	Key for Motor 5,5 HP CT200		0,00
56-160-K1-5	Side Exhaust for Motor CT200		0,00
90-24-11-08-1,5HP-US	Taperlock Motor CT200 1,5 HP 115 Volt	US Version	130,00
95-10-200-42-10-K	Complete Drum with Milling Flails 42/10	40 Pieces CT 200	7,65
95-10-200-42-12-K	Complete Drum with Steel Beam Flails	42/12 CT 200	6,95
95-10-200-K	Complete Drum with tipped Tungston Cutter	CT 200	7,75
95-10-200-T	Drum for CT200		3,55
95-16-10-200	Wire Brush CT 200		0,00
95-16-42-10-40	Set Milling Flail Cutters 42 / 10 CT200	1 Set = 40 Pieces	3,04
95-16-42-12-124	Steel Cutters Beam Flails 42 / 12	CT 200 1 Set = 124 pieces	1,49
95-16-45-05-76	Set Tungston Carbide Cutters 45 / 5	CT 200 1 Set = 76 Pieces	2,89
95-16-45-06	Tungston Carbide Cutters 45/6 CT200/350		44,00
95-16-45-06-76	Set Tungston Carbide Cutters 45/6 CT200	1 Set = 76 Pieces	3,44